

Examples of two- and three-dimensional graphics in Smath Studio

By Gilberto E. Urroz, October 2010

Basic commands using the "Insert" menu:

To insert a two-dimensional (2D) graph, use:

Insert > Plot > 2D

To insert a three-dimensional (3D) graph, use:

Insert > Plot > 3D**EXAMPLE 1A - Plotting a single function of x:**

- 1 - Click on point in your worksheet where you want to set the upper left corner of graph
- 2 - Click on the "2D" icon in the "Functions" palette or use the "Insert > Graph > 2D" menu option
- 3 - Type the function name in the placeholder below the graph.

In this example we plot the function: $f(x) = \sin(x)$

Thus, type: " $\sin(x)$ ", then click somewhere in the worksheet outside of the graph.

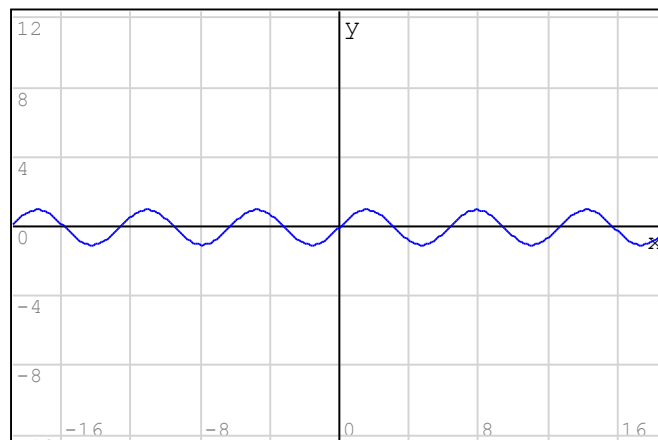
 $\sin(x)$ **EXAMPLE 1B - Plotting a single function of (x,y):**

- 1 - Click on point in your worksheet where you want to set the upper left corner of graph
- 2 - Click on the "3D" icon in the "Functions" palette or use the "Insert > Graph > 3D" menu option
- 3 - Type the function name in the placeholder below the graph.

In this example we plot the function: $f(x) = x \cdot \sin(y)$

Thus, type: " $x \cdot \sin(y)$ ", then click somewhere in the worksheet outside of the graph.

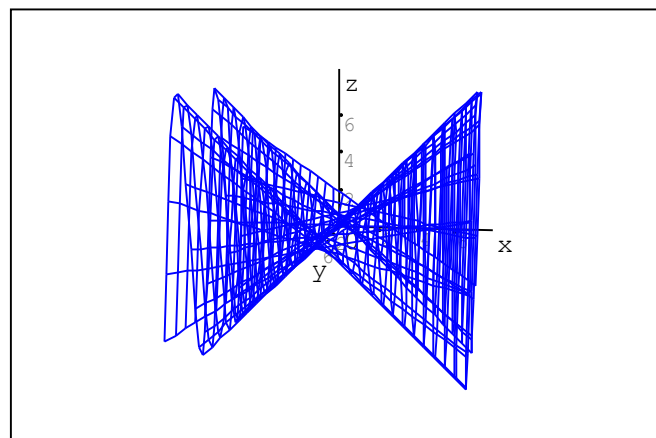
 $x \cdot \sin(y)$ Using icons in the "Functions" palette:

Click on the "2D" or "3D" icon in the palette to insert a 2D or 3D graph: -> -> -> -> -> -> -> ->

Also, use the "Multiple Values" icon -> ->  to plot more than one function.

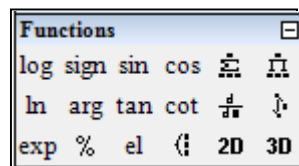
**EXAMPLE 2A - Plotting two functions of x in 2D:**

- 1 - Click on point in your worksheet where you want to set the upper left corner of graph
- 2 - Click on the "2D" icon in the "Functions" palette or use the "Insert > Graph > 2D" menu option
- 3 - Click on the placeholder below the graph
- 4 - Click on the "Multiple values" icon, then type the functions to be plotted in each placeholder in the open brace

In this example we plot the functions: " $\sin(x)$ " and " $\cos(x)$ ", then click somewhere in the worksheet outside of the graph.

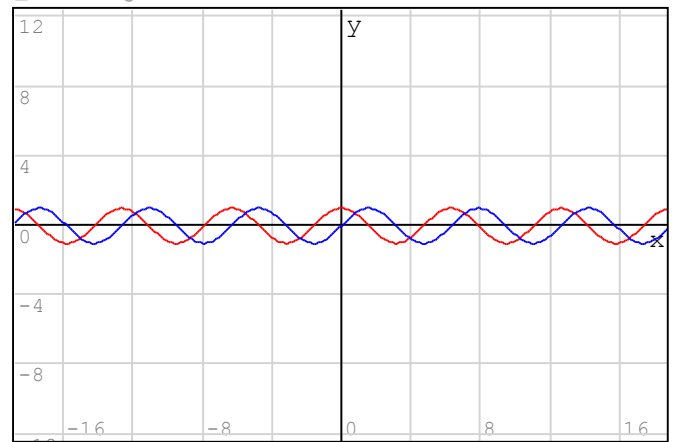

$$\begin{cases} \sin(x) \\ \cos(x) \end{cases}$$

EXAMPLE 2B - Plotting two functions of (x,y) in 3D:

- 1 - Click on point in your worksheet where you want to set the upper left corner of graph
- 2 - Click on the "3D" icon in the "Functions" palette or use the "Insert > Graph > 3D" menu option
- 3 - Click on the placeholder below the graph
- 4 - Click on the "Multiple values" icon, then type the functions to be plotted in each placeholder in the open brace

In this example we plot the functions: " $x \cdot \sin(y)$ " and " $x + y$ ", then click somewhere in the worksheet outside of the graph.

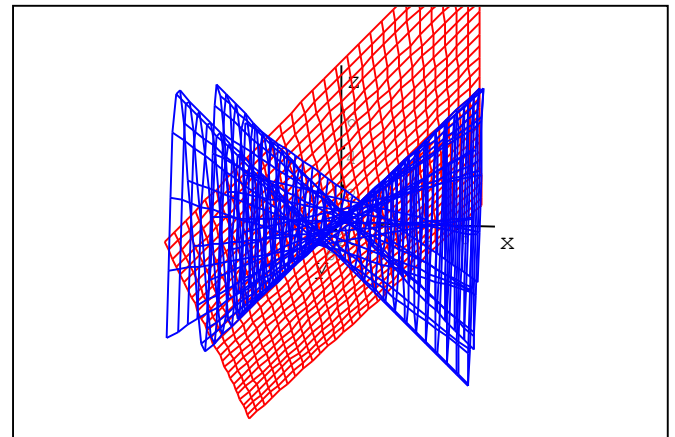

$$\begin{cases} x \cdot \sin(y) \\ x + y \end{cases}$$

Adding more entries to the "Multiple values" icon: 

The "Multiple values" icon produces two entries by default. However, you can insert more entries by following this procedure:

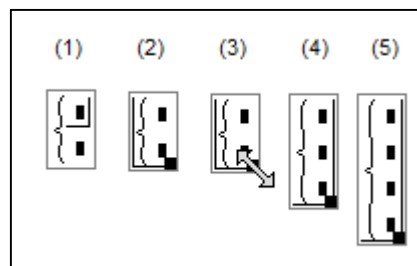

- (1) Click somewhere in the worksheet, then click on the "Multiple value" icon in the "Functions" palette, to produce the "Multiple values" brace as shown. This figure shows the default case of "Multiple values," i.e., a brace with two entries.
- (2) Click on the left-hand side of the frame of (1) to produce the holder in the lower right corner as shown.
- (3) Place the mouse over the holder until the double arrow icon shows up ...
- (4) then, immediately drag the holder down to insert a third entry in the "Multiple values" brace.
- (5) If needed, repeat steps (2) through (4) to add more entries to the "Multiple values" brace.

EXAMPLE 3A - Plotting three functions of x in 2D:

- 1 - Click on point in your worksheet where you want to set the upper left corner of graph
- 2 - Click on the "2D" icon in the "Functions" palette or use the "Insert > Graph > 2D" menu option
- 3 - Click on the placeholder below the graph
- 4 - Click on the "Multiple values" icon in the "Function" palette
- 5 - Add one more entry to the "Multiple values" brace.

In this example we plot the functions: " $\sin(x)$ ", " $\cos(x)$ ", and " $\sin(2 \cdot x)$ " then click somewhere in the worksheet outside of the graph.

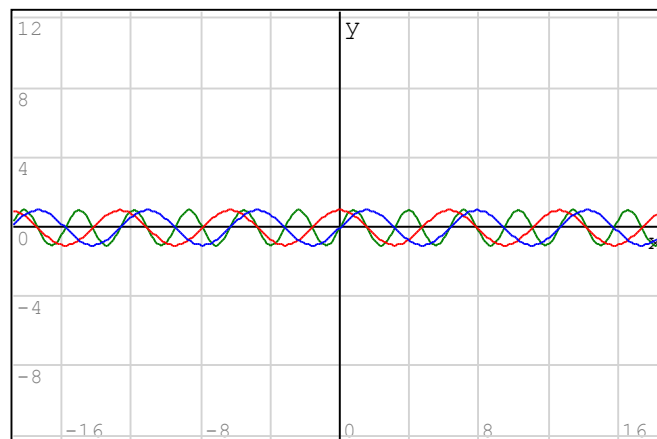

$$\left\{ \begin{array}{l} \sin(x) \\ \cos(x) \\ \sin(2 \cdot x) \end{array} \right.$$

As you add functions to plot, SMath Studio uses the following colors for the plots:

- | | |
|-----------|-------------------|
| 1 - blue | 2 - red |
| 3 - black | 4 - magenta, etc. |

EXAMPLE 3B - Plotting three functions of (x, y) in 3D:

- 1 - Click on point in your worksheet where you want to set the upper left corner of graph
- 2 - Click on the "3D" icon in the "Functions" palette or use the "Insert > Graph > 3D" menu option
- 3 - Click on the placeholder below the graph
- 4 - Click on the "Multiple values" icon in the "Function" palette
- 5 - Add one more entry to the "Multiple values" brace.

In this example we plot the functions: " $x \cdot \sin(y)$ ", " $x+y$ ", and " $x-y$ " then click somewhere in the worksheet outside of the graph.

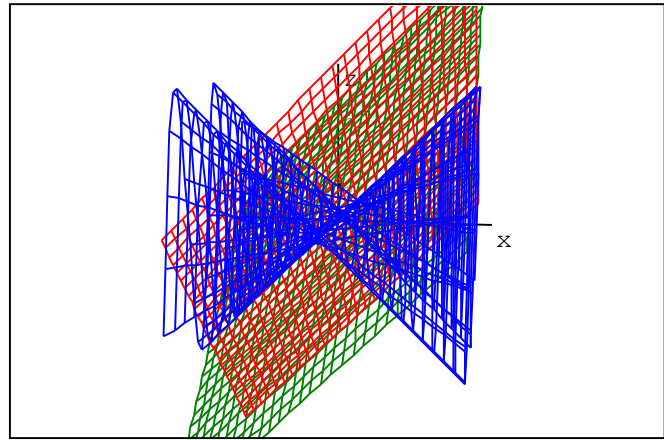

$$\begin{cases} x \cdot \sin(y) \\ x + y \\ x - y \end{cases}$$

Icons in the "Plot" palette: -> -> -> -> -> -> ->

- (1) Rotate: Rotate a 3D graph only
- (2) Scale: (see instructions below)
- (3) Move: drag graph up or down, left or right
- (4) Graph by points: show points instead of lines
- (5) Graph by lines: show lines (default)
- (6) Refresh: restore to original version of graph

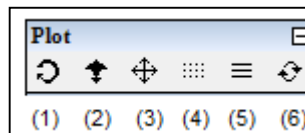

Details of "Scale" in a 2D graph:

- * ZOOM IN or OUT: Click on the "Scale" icon, icon (2), then click on the graph (also for 3D plots):
 - ZOOM IN: Drag the mouse inwards, towards the origin, to decrease size of axes divisions
 - ZOOM OUT: Drag the mouse outwards, away from the origin, to increase size of axis divisions
- * Alternatively, to ZOOM IN or OUT, click on the "Scale" icon, click inside the graph and use the mouse wheel (also for 3D plots):
 - ZOOM IN: roll mouse wheel up
 - ZOOM OUT: roll mouse wheel down
- * ZOOM IN or OUT on the x-axis only: Click on the "Scale" icon, click on the graph, hold the [SHIFT] key, then:
 - ZOOM IN X-AXIS: roll mouse wheel up
 - ZOOM OUT X-AXIS: roll mouse wheel down
- * ZOOM IN or OUT on the y-axis only: Click on the "Scale" icon, click on the graph, hold the [CTRL] key, then:
 - ZOOM IN Y-AXIS: roll mouse wheel up
 - ZOOM OUT Y-AXIS: roll mouse wheel down

EXAMPLE 4A - Changing the size of the graph window in 2D:

Click on the graph window, then drag one of the three black handlers in the graph window to adjust its size

(1)

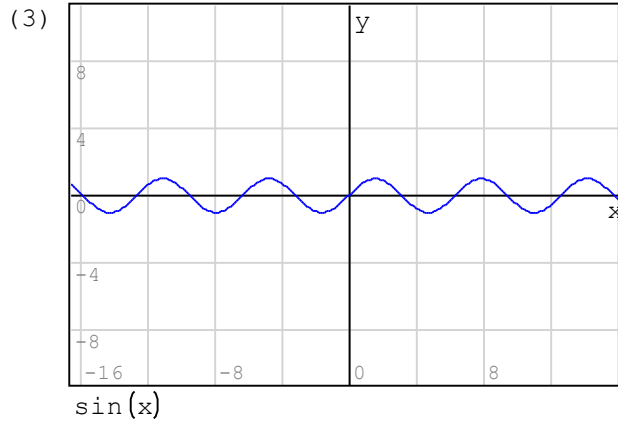
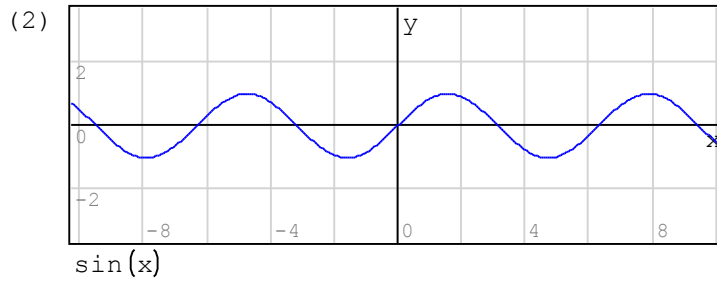
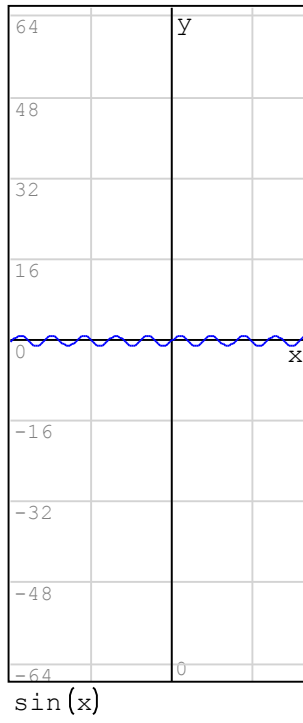

For the graphs above:

- (1) Dragging the right-hand side handler to shorten the width, and the bottom handler to enlarge the height of the graph.
- (2) Dragging the bottom handler to reduce the height of the graph.
- (3) Dragging the right-bottom corner handler to reduce the size proportionally

EXAMPLE 4B - Changing the size of the graph window in 3D:

The procedure is very similar to that of a 2D graph.

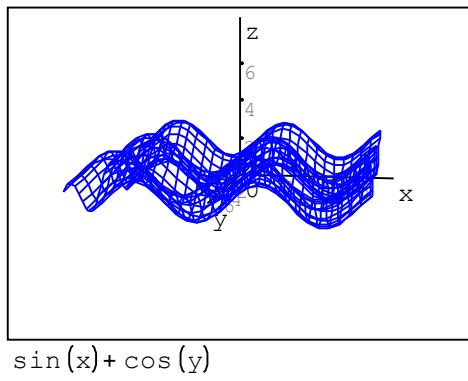
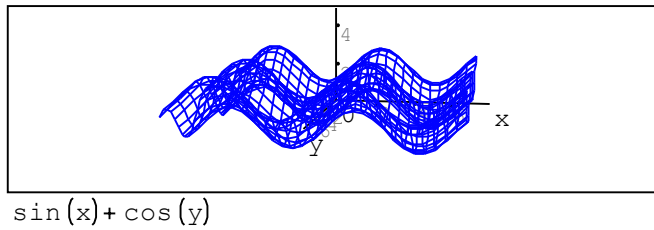
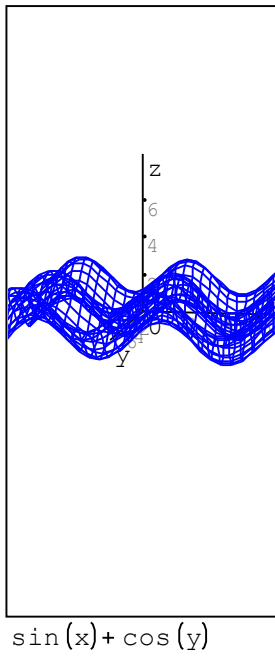

EXAMPLE 5A - Moving the axes about the graph window (2D):

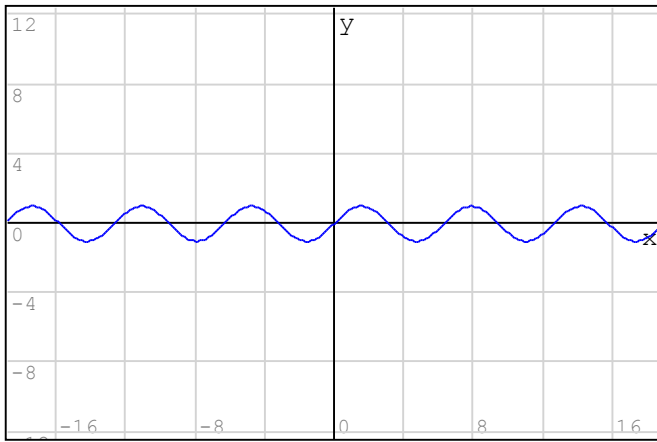

$\sin(x)$

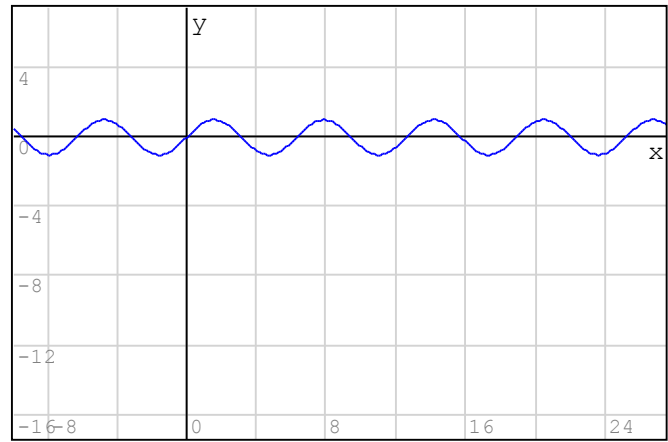

$\sin(x)$

- 1 - Click on the "Move" option in the "Plot" palette
- 2 - Click on the graph window and drag the mouse in the direction where you want to move the axes.

EXAMPLE 5B - Moving the axes about the graph window (3D) :

The procedure is very similar to that of a 2D graph.

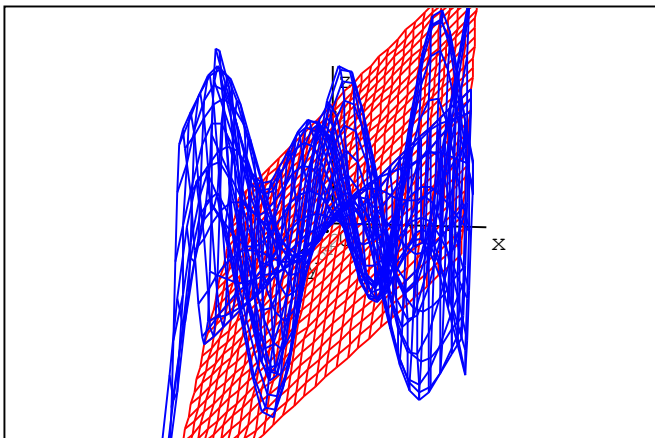

$$\begin{cases} x \cdot \cos(y) + y \cdot \sin(x) \\ x - y \end{cases}$$

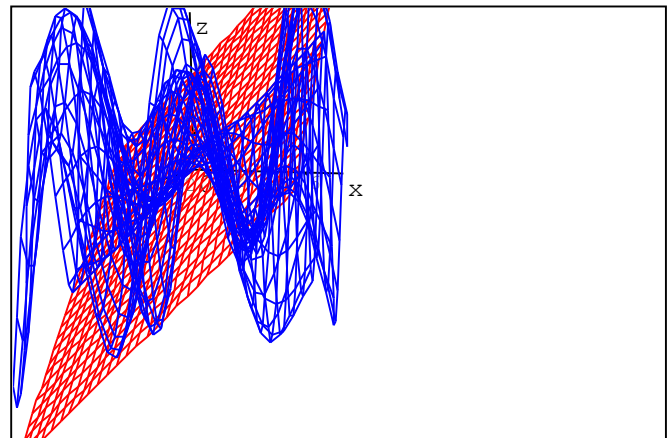

$$\begin{cases} x \cdot \cos(y) + y \cdot \sin(x) \\ x - y \end{cases}$$

Details of "Scale" in a 2D graph (repeated) :

- * ZOOM IN or OUT: Click on the "Scale" icon, icon (2), then click on the graph (also for 3D plots):
 - ZOOM IN: Drag the mouse inwards, towards the origin, to decrease size of axes divisions
 - ZOOM OUT: Drag the mouse outwards, away from the origin, to increase size of axis divisions
- * Alternatively, to ZOOM IN or OUT, click on the "Scale" icon, click inside the graph and use the mouse wheel (also for 3D plots):
 - ZOOM IN: roll mouse wheel up
 - ZOOM OUT: roll mouse wheel down
- * ZOOM IN or OUT on the x-axis only: Click on the "Scale" icon, click on the graph, hold the [SHIFT] key, then:
 - ZOOM IN X-AXIS: roll mouse wheel up
 - ZOOM OUT X-AXIS: roll mouse wheel down
- * ZOOM IN or OUT on the y-axis only: Click on the "Scale" icon, click on the graph, hold the [CTRL] key, then:
 - ZOOM IN Y-AXIS: roll mouse wheel up
 - ZOOM OUT Y-AXIS: roll mouse wheel down

EXAMPLE 6A - Scaling (zooming) a 2D graph:

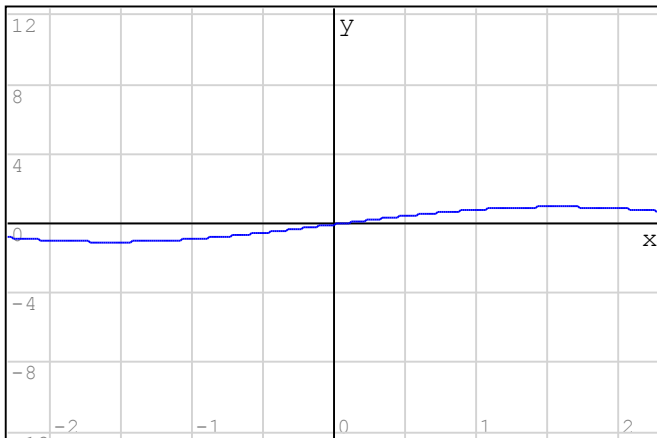

$\sin(x)$

- To zoom the y-axis only: ----->
- 1 - Click on "Scale" in the "Plot" palette
 - 2 - Click on the graph window
 - 3 - Hold down the "Control" key
 - 4 - Roll the mouse wheel up or down

<--- To zoom the x-axis only:

- 1 - Click on "Scale" in the "Plot" palette
- 2 - Click on the graph window
- 3 - Hold down the "Shift" key
- 4 - Roll the mouse wheel up or down

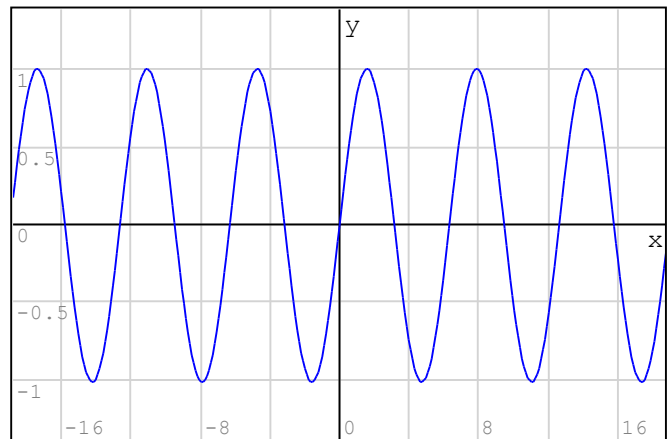

$\sin(x)$

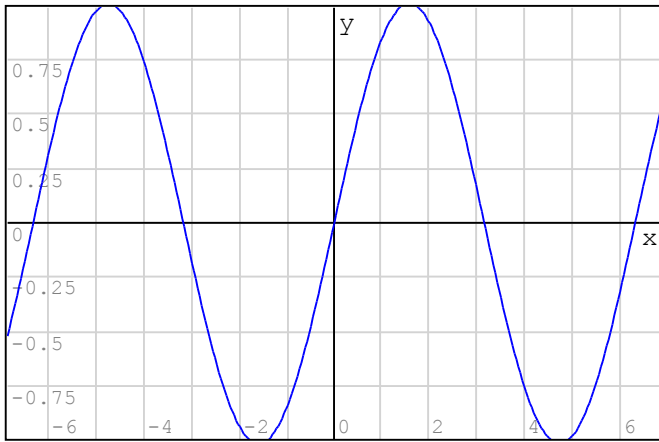

sin(x)

<--- You can zoom both axes by zooming one axis at a time. In this case, I zoomed the x axis first, and then the y axis.

Note: Use the "Refresh" option in the "Plot" menu to recover the original version of any plot.

EXAMPLE 6B - Scaling (zooming) a 3D graph:

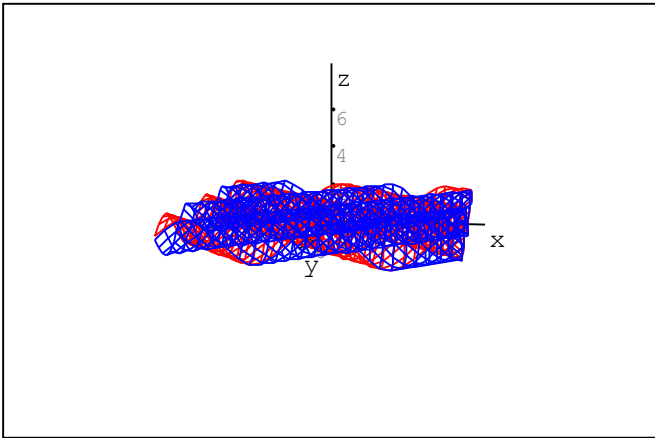

$\begin{cases} \sin(x+y) \\ \cos(x-y) \end{cases}$

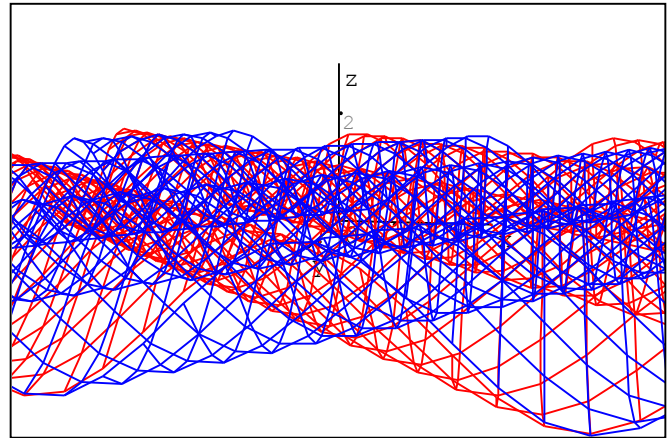

$\begin{cases} \sin(x+y) \\ \cos(x-y) \end{cases}$

Examples of other types of graphs in 2-D

The following examples show other ways to produce 2D graphics. Data for a graph $y = f(x)$ can be generated by using a vector of values of x , then generating a vector of values of y . The two vectors are then put together into a matrix, whose name is used in the 2D graph placeholder instead of $f(x)$.

EXAMPLE 7 - Plotting a function using vectors:

Vectors of x and y data are created using ranges, example:

```
x:=- pi , - pi + pi/20 .. pi
```

```
n:= length(x)
n= 41
```

```
Create x vector as follows
Type: x : range - p cntl-G , p cntl-G ,
      - p cntl-G + p cntl-G / 20
```

Calculate the length of vector = n

```
for k ∈ 1..n
  yk := sin(xk)2 + sin(2·xk)
```

```
M := augment(x, y)
```

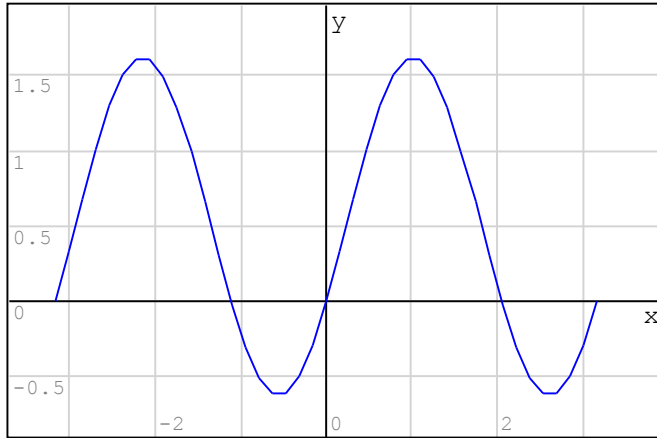

M

Fill out y vector using a for loop. Click "for" in the "Programming" palette, then use: range 1 , n

Use sub-indices, e.g., y [k ... etc.

Form augmented matrix M with vectors x and y, place M in graph as a function name:

< --- The graph was zoomed in and the axes moved by using the following procedures:

- 1 - To zoom x-axis only: click on "Scale" in the "Plot" palette, hold the "Control" key, and use the mouse wheel
- 2 - To zoom y-axis only: click on "Scale" in the "Plot" palette, hold the "Shift" key and use the mouse wheel
- 3 - To move axes, drag mouse across graph window

Using points or lines for a plot:

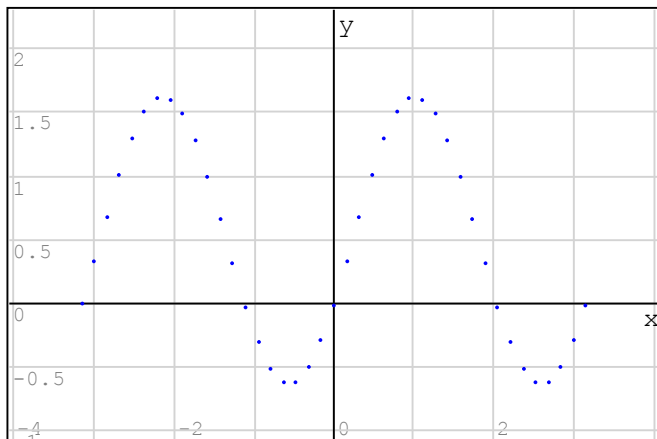

M

Using the sparse data in matrix M we reproduce the graph above, but then we selected the "Graph by points" option in the "Plot" palette to produce the graph shown to the left.

You can click the option "Graph by lines" option in the "Plot" palette to return to the default graph format of continuous lines.

EXAMPLE 8 - Plotting a function and a matrix

In this example we plot the function $y = \cos(x)$ and a matrix M with vector data of $y = \sin(x)$ in the range $-\pi < x < \pi$.

```
x := -π, -π + π/20 .. π   n := length(x)   n = 41
```

```
for k ∈ 1..n
  yk := sin(xk)
```

```
M := augment(x, y)
```

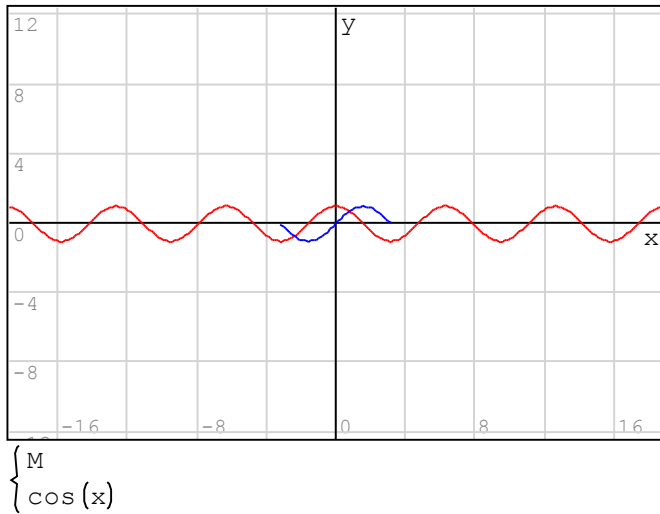

1 - Original graph

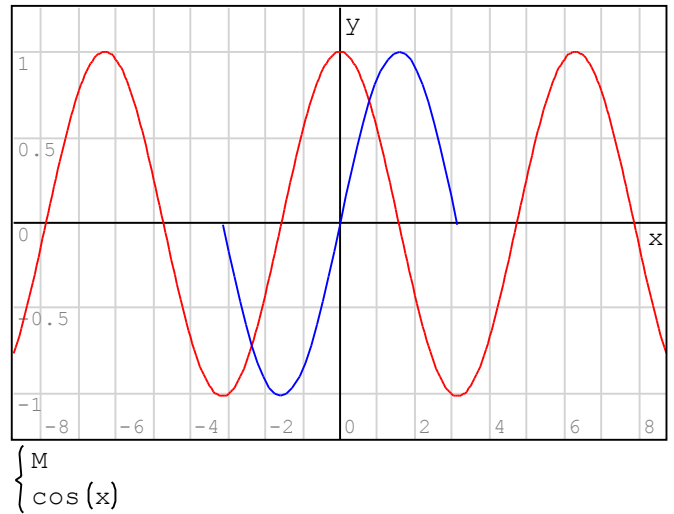

2 - Zooming In in both x and y

EXAMPLE 9 - Parametric plots in 2D using matrices:

Parametric plots are plots of the form $x = x(t)$, $y = y(t)$. A parametric plot can be generated by using vectors and matrices as illustrated below. Use a fine grid for the parameter t to produce a continuous curve.

$$t := -\pi, -\pi + \frac{\pi}{50} \dots \pi$$

$$n := \text{length}(t)$$

for $k \in 1 \dots n$

$$\begin{cases} x_k := \sin(3 \cdot t_k) \\ y_k := 2 \cdot \cos(2 \cdot t_k) \end{cases}$$

$$M := \text{augment}(x, y)$$

Define the vector of the parameter t

Determine length of vector $t = n$

Calculate vectors of $x = x(t)$ and $y = y(t)$

Produce matrix of (x, y) and plot it

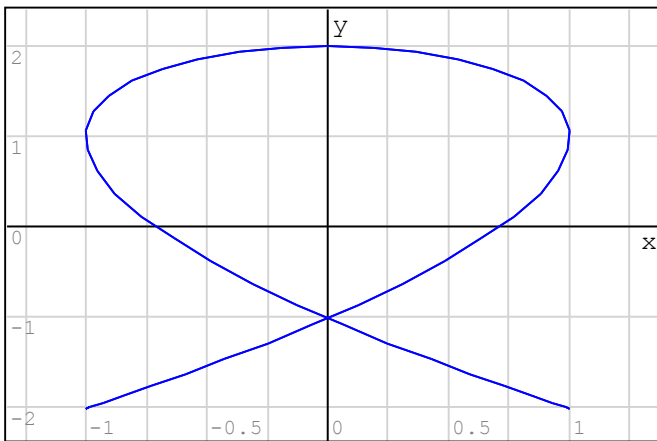

M

1 - Using "Plot by Lines" option in the "Plot" palette

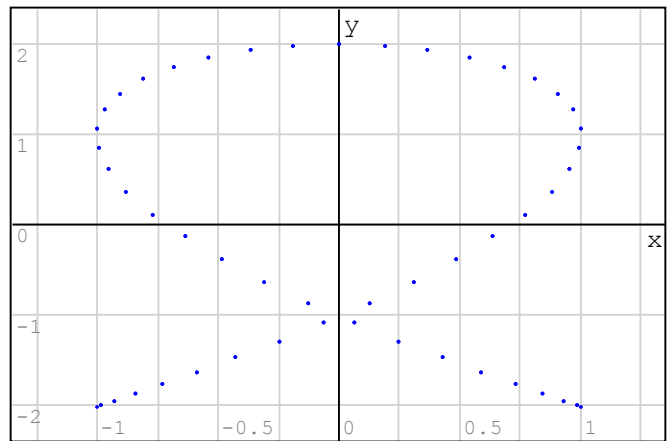

M

2 - Using "Plot by Lines" option in the "Plot" palette

EXAMPLE 10 - Polar plots produced using vectors and matrices:

Polar plots are similar to parametric plots. In polar plots the independent variable is the angle θ , and the dependent variable is the radial position r , i.e., $r = f(\theta)$. To produce the plot the (x, y) coordinates are calculated using $x = r \cdot \cos(\theta)$ and $y = r \cdot \sin(\theta)$ as illustrated below.

```

 $\theta := 0, \frac{\pi}{50} \dots 2 \cdot \pi$ 
n := length( $\theta$ )
for k  $\in$  1 .. n
   $r_k := 2 \cdot (1 + 2 \cdot \sin(\theta_k))$ 
for k  $\in$  1 .. n
   $xx_k := r_k \cdot \cos(\theta_k)$ 
   $yy_k := r_k \cdot \sin(\theta_k)$ 
P := augment(xx, yy)
    
```

Generate vector of θ between 0 and 2π
 Determine length of vector θ
 Generate values of $r = f(\theta)$
 Generate coordinates:
 $x = r \cos(\theta)$
 $y = r \sin(\theta)$
 Produce matrix of (x, y) and plot it

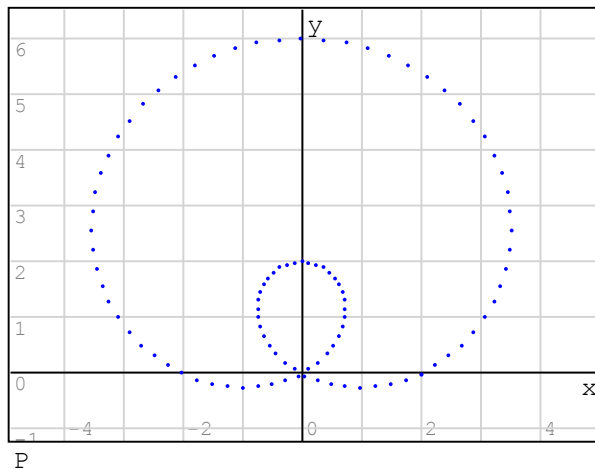
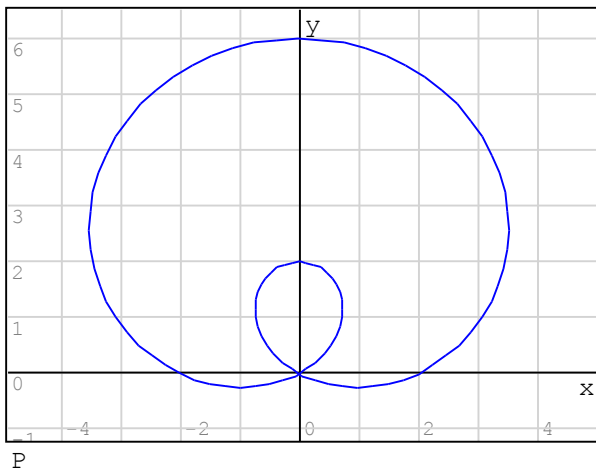

1 - Using "Plot by Lines" option in the "Plot" palette

2 - Using "Plot by Lines" option in the "Plot" palette

EXAMPLE 11 - Parametric plot in three-dimensions - space curves

Parametric equations of the form $x = x(t)$, $y = y(t)$, $z = z(t)$, produces a space curve. To generate the graph, use a vector of values of t , and then calculate the corresponding vectors of values of x , y , and z . Put together a matrix whose columns are the x, y, z data, and use a 3D plot.

```

t := 0, 0.1 .. 10
n := length(t)
n = 101
    
```

Create a vector t with values of the parameter that will produce $x = x(t)$, $y = y(t)$, and $z = z(t)$.
 Determine the length of vector t

for k ∈ 1..n

Generate vectors x, y, and z using a "for" loop

$$\begin{cases} x_k := \sin(t_k) \\ y_k := \cos(t_k) \\ z_k := \frac{t_k}{2} \end{cases}$$

M := augment(x, y, z)

Build matrix M with coordinates (x, y, z)

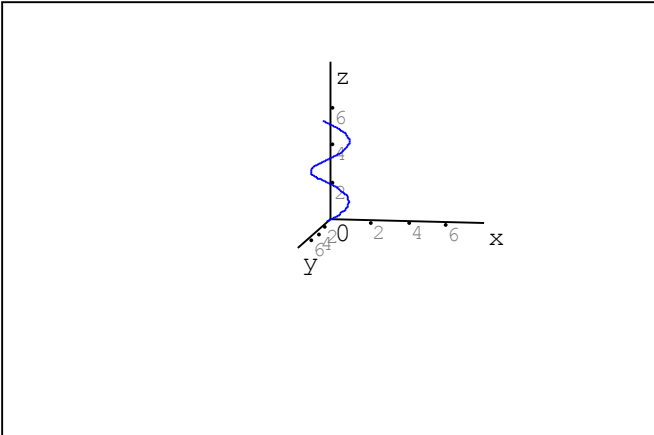

Plot matrix M in a 3D plot

M

EXAMPLE 12 - Using 2D graphs in solving equations:

In this example we seek the solution(s) for the equation:

$$x^2 + 1 = x^3 + 2 \cdot x - 5$$

A solution can be found by determining the intersection of the functions:

$$f(x) := x^2 + 1 \quad g(x) := x^3 + 2 \cdot x - 5$$

Using graphics and zooming the intersection we estimate the solution to be close to $x = 1.80$

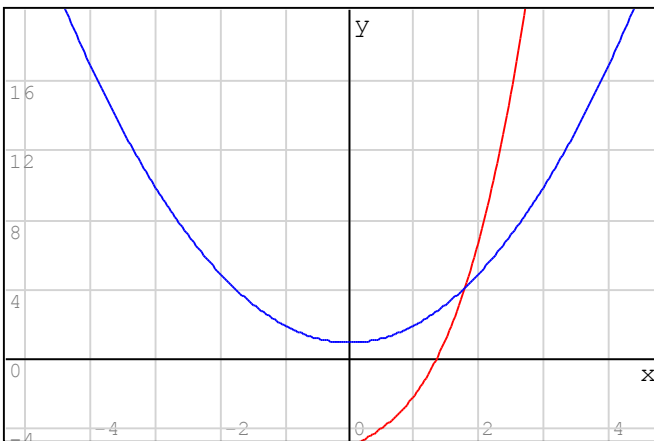

$\begin{cases} f(x) \\ g(x) \end{cases}$

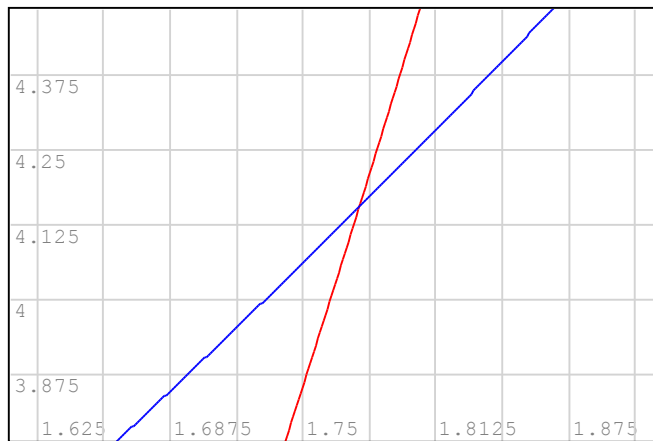

$\begin{cases} f(x) \\ g(x) \end{cases}$

The exact solution can be found using: $\text{solve}(x^2 + 1 = x^3 + 2 \cdot x - 5, x) = 1.78$

EXAMPLE 12 - Graphical solution for a pump-pipeline system (Civil Engineering Hydraulics)
PROBLEM [3].

A pipeline with a length of 1000 ft, diameter of 0.15 ft, absolute roughness of 5×10^{-6} ft, connects two reservoirs such that the upstream reservoir is 6.0 ft below the upstream reservoir. The kinematic viscosity of the water is 1.2×10^{-5} ft²/s. In calculating minor losses use entrance, discharge, and valve coefficients of 0.5, 1.0, and 6.0, respectively. Determine the operating point for this system if we use a pump LR-15B whose pump curve is shown in the figure of Problem [2].

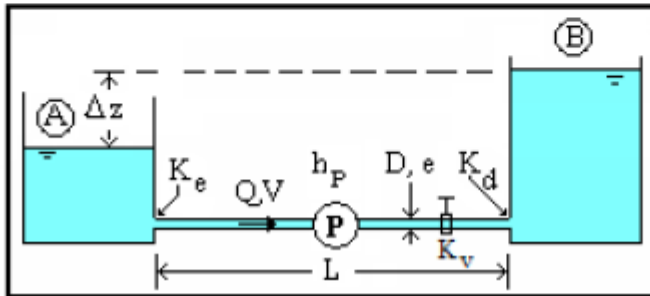

Solution: Write out all the given data without units, but using the proper set of units for the English System:

$$L := 1000 \quad (\text{ft}) \quad D := 0.15 \quad (\text{ft}) \quad ee := 5 \cdot 10^6 \quad (\text{ft}) \quad \Delta z := 6 \quad (\text{ft})$$

$$v := 1.2 \cdot 10^{-5} \quad (\text{ft}^2/\text{s}) \quad g := 32.2 \quad (\text{m}/\text{s}^2) \quad \Sigma Km := 0.5 + 1.0 + 6.0, \text{ i.e., } \Sigma Km = 7.5$$

For the pump: $a := 14.09 \quad b := -138.02 \quad c := -2267.62$

Using the Swamee-Jain equation for the friction factor:

$$f_{SJ}(k, r) := \frac{0.25}{\left(\log_{10} \left(\frac{k}{3.7} + \frac{5.74}{r} \right) \right)^2}$$

the system equation becomes:
$$h_P = \Delta z + \frac{8 \cdot Q^2}{\pi^2 \cdot g \cdot D^4} \cdot \left(\Sigma Km + f_{SJ} \left(\frac{ee}{D}, \frac{4 \cdot Q}{\pi \cdot v \cdot D} \right) \cdot \frac{L}{D} \right) \quad [1]$$

The pump equation is:
$$h_P = a + b \cdot Q + c \cdot Q^2 \quad [2]$$

A graphical analysis shows the solution as the intersection of the system and the pump curves, i.e.,

$$h_{P1}(Q) := \Delta z + \frac{8 \cdot Q^2}{\pi^2 \cdot g \cdot D^4} \cdot \left(\Sigma Km + f_{SJ} \left(\frac{ee}{D}, \frac{4 \cdot Q}{\pi \cdot v \cdot D} \right) \cdot \frac{L}{D} \right) \quad h_{P2}(Q) := a + b \cdot Q + c \cdot Q^2$$

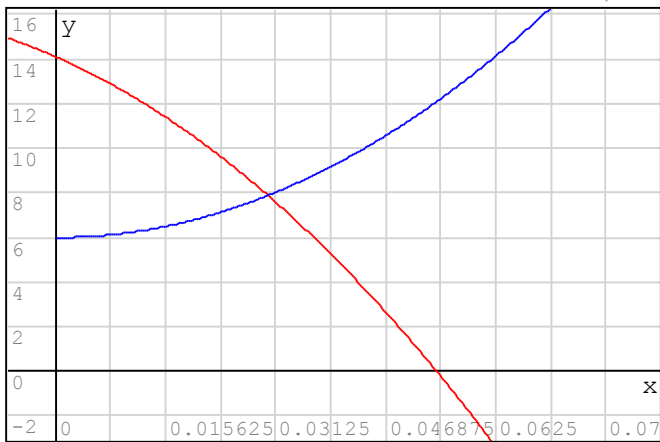

$\begin{cases} \text{hP1}(x) \\ \text{hP2}(x) \end{cases}$

Notice that, even though we defined hP1 and hP2 as functions of Q, when using the 2D plot, we need to define them as functions of x.

The exact solution can be found by solving the equation: $\text{hP1}(Q) = \text{hP2}(Q)$

$$\text{solve}(\text{hP1}(Q) = \text{hP2}(Q), Q, 0, 1) = 3.01 \cdot 10^{-2}$$

EXAMPLE 14 - More examples of three-dimensional graphs - surfaces:

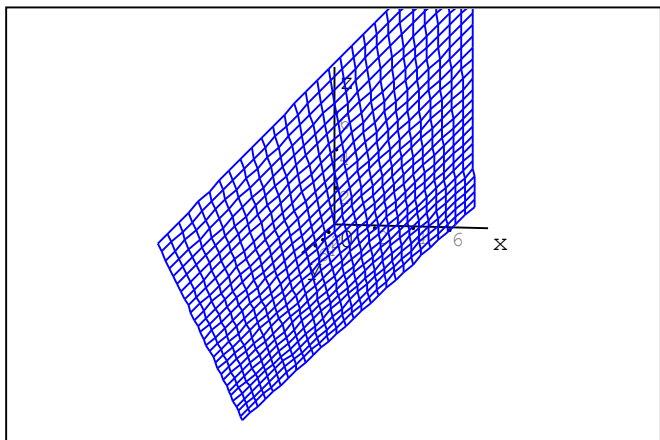

x + y

Use the option "3D" in the "Functions" palette, and enter the function f(x,y) in the placeholder. The result is a 3D surface, in this case, a plane. The original plot is shown above.

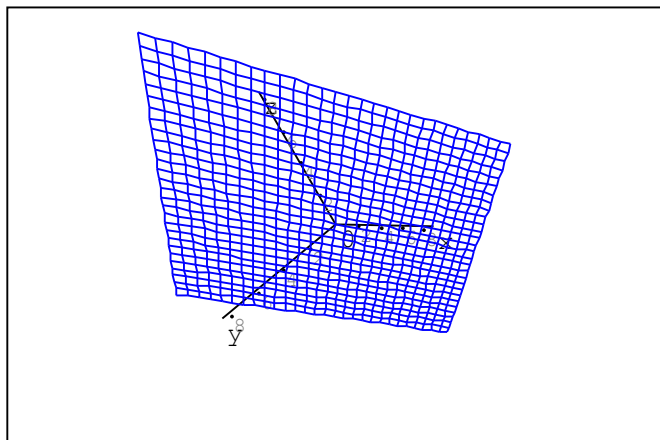

x + y

Use the "Rotate" option in the "Plot" palette to change the surface view.

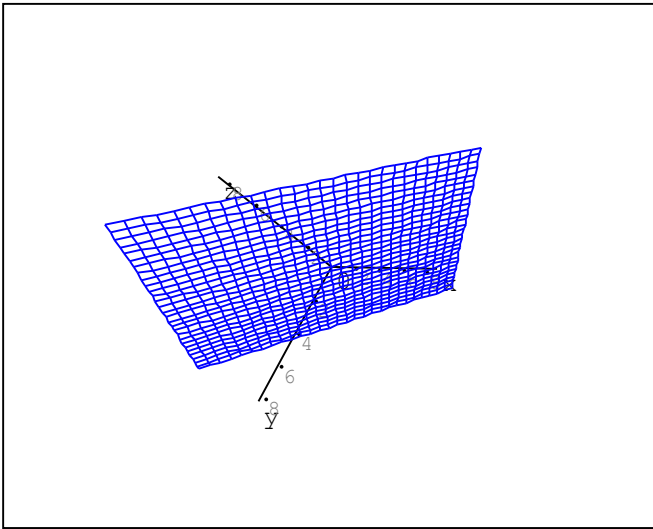

$x + y$

This figure uses the option "Graph by Lines" in the "Plot" palette (default).

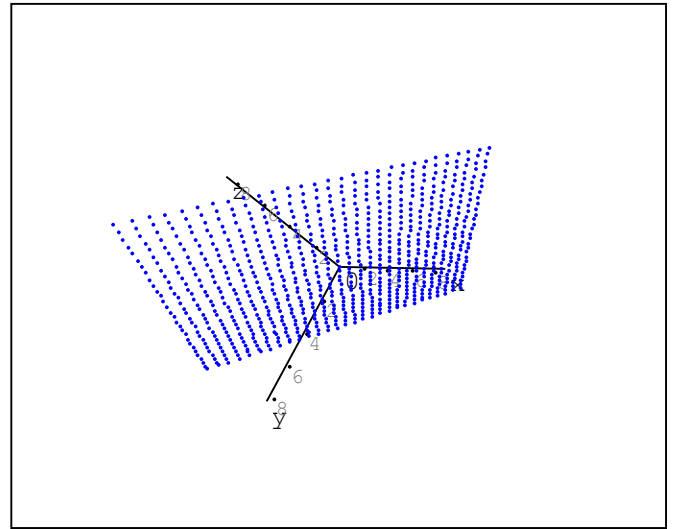

$x + y$

This figure uses the option "Graph by Points" in the "Plot" palette.

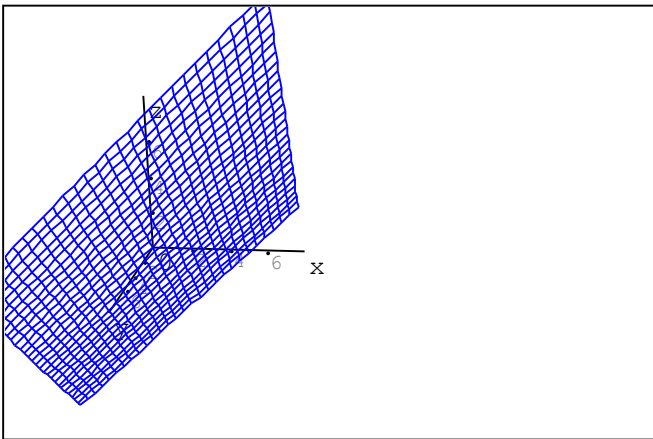

$x + y$

Use the "Move" option in the "Plot" palette to move the location of the origin in the graphics window.

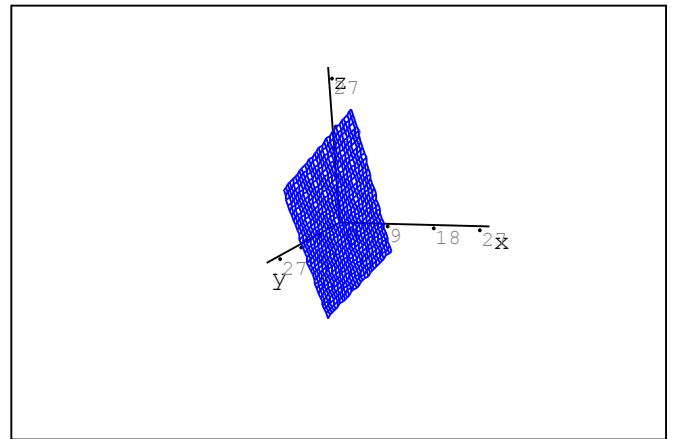

$x + 2 \cdot y$

Use the "Scale" option in the "Plot" palette, click on the graph, and drag the mouse over it to zoom in or out.

Note: Use the "Refresh" option in the "Plot" menu to recover the original version of any plot.

EXAMPLE 15 - The following examples use more complex 3D surfaces:

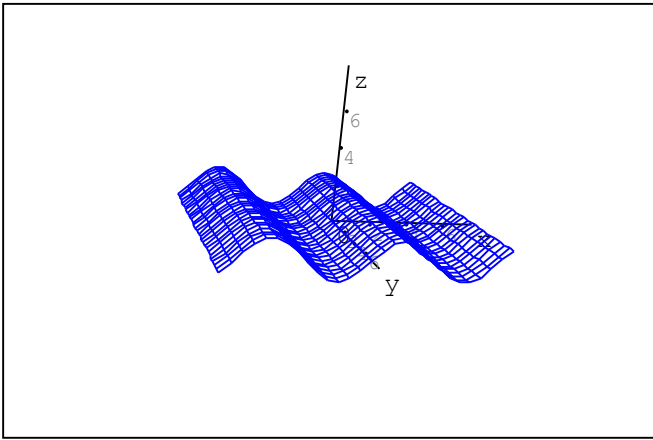

$$\sin(x)$$

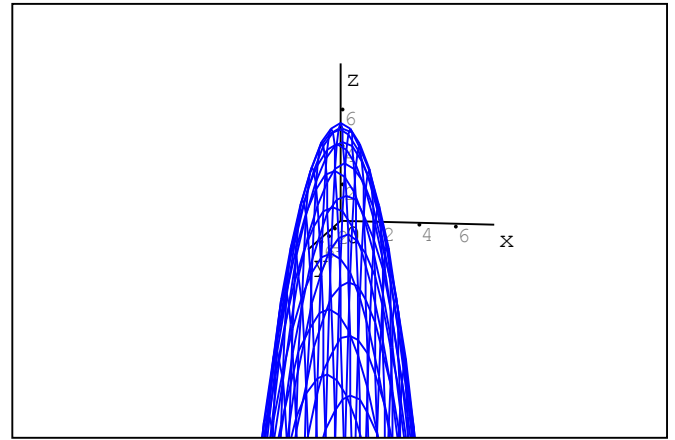

$$5 - (x^2 + y^2)$$

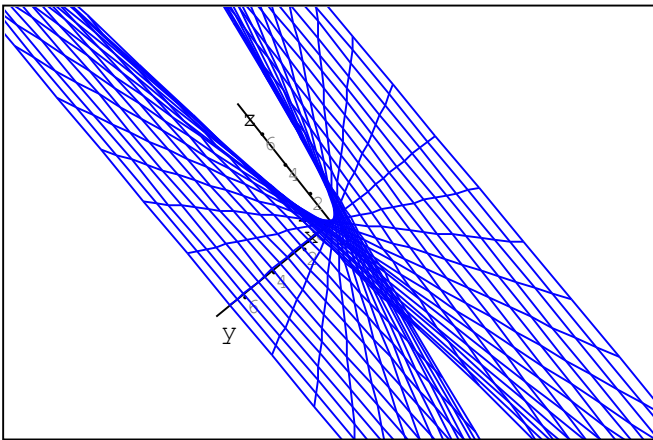

$$x \cdot y$$

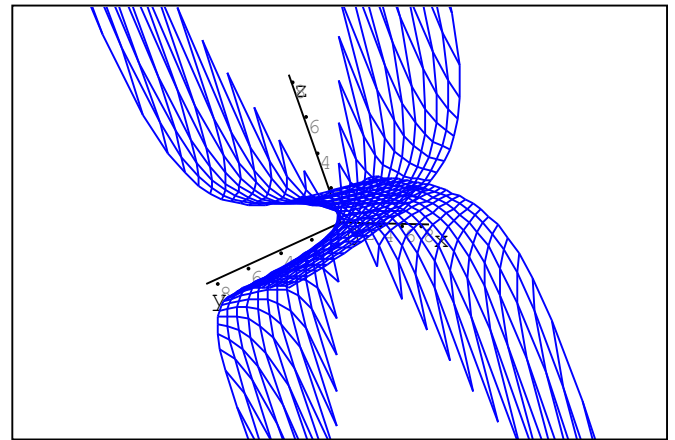

$$\frac{x - y}{x + y}$$

The type of 3D graphs of surfaces produced by SMath Studio are referred to as wireframe plots.

EXAMPLE 16 - The following examples show more than one surface plot together in 3D:

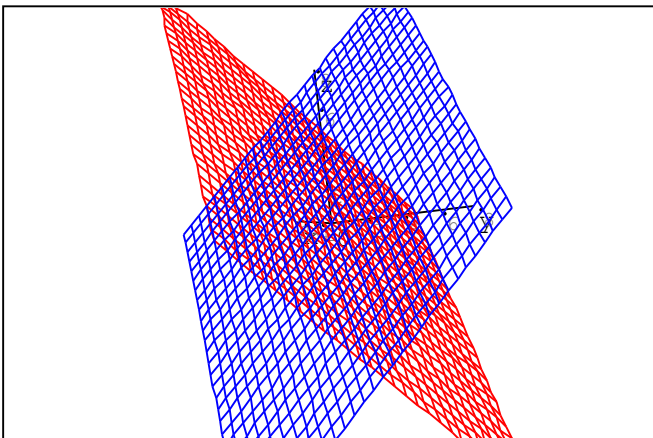

$$\begin{cases} x + y \\ x - y \end{cases}$$

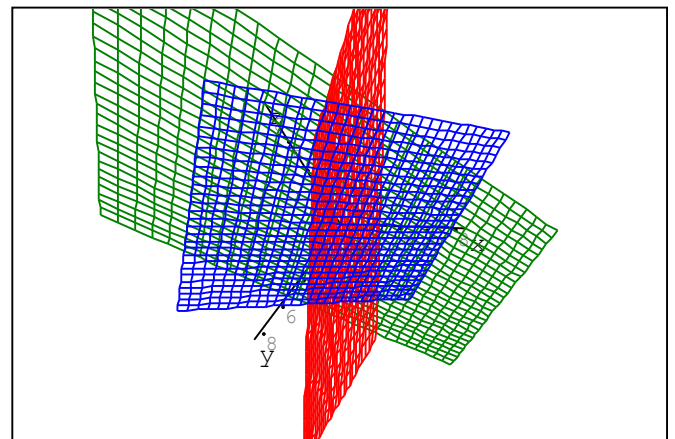

$$\begin{cases} x + y \\ x - y \\ x + 2 \cdot y \end{cases}$$

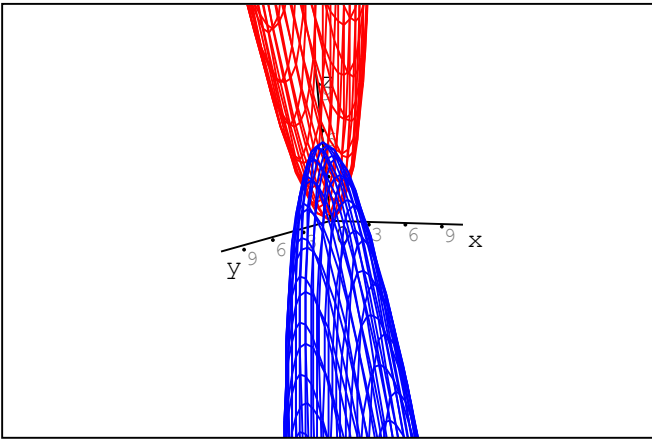

$$\begin{cases} 5 - (x^2 + y^2) \\ x^2 + y^2 \end{cases}$$

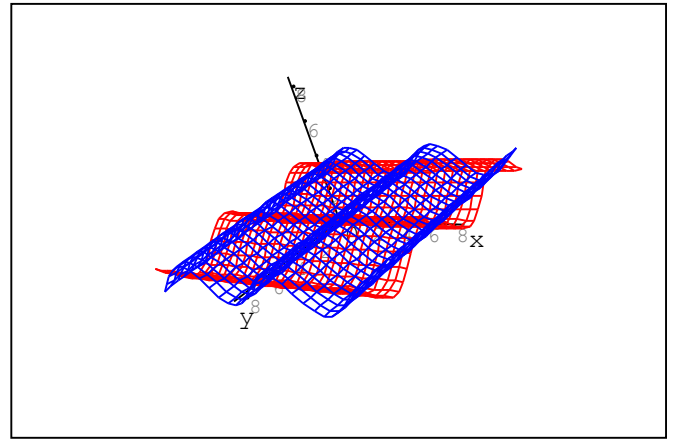

$$\begin{cases} \sin(x) \\ \sin(y) \end{cases}$$

EXAMPLE 17 - Drawing a surface and a space curve together:

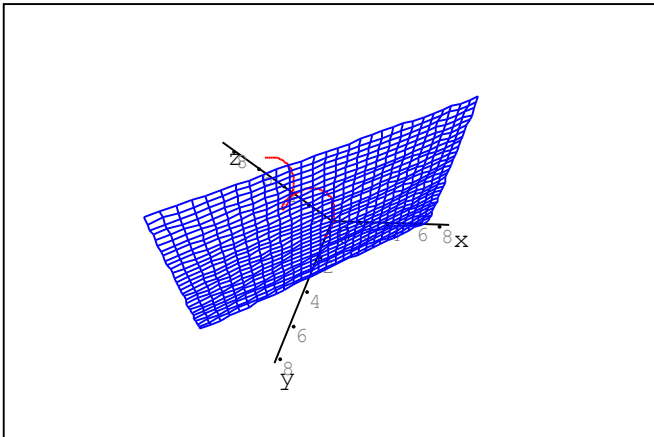

$$\begin{cases} x + y \\ M \end{cases}$$

Use the "Multiple values" option in the "Plot" palette, and enter the equation of the surface (e.g., $x+y$) and the matrix that represents the space curve (e.g., M)

EXAMPLE 18 - Plotting 2 space curves:

```
t:=-2,-1.9..2
```

```
n:=length(t)
```

```
n=40
```

```
for k∈1..n
```

$$\begin{cases} x1_k := 1 + 5 \cdot t_k \\ y1_k := -1 + 4 \cdot t_k \\ z1_k := 1 + 8 \cdot t_k \end{cases}$$

```
P:=augment(x1, y1, z1)
```

In this example two straight lines in 3D are produced by using linear parametric equations.

Vector t is the parameter, and the coordinates of the two curves are given by $(x1, y1, z1)$ and $(x2, y2, z2)$. These lines are represented by the matrices P and Q , respectively.

```
for k∈1..n
```

$$\begin{cases} x2_k := 1 + 3 \cdot t_k \\ y2_k := -1 + t_k \\ z2_k := t_k \end{cases}$$

```
Q:=augment(x2, y2, z2)
```

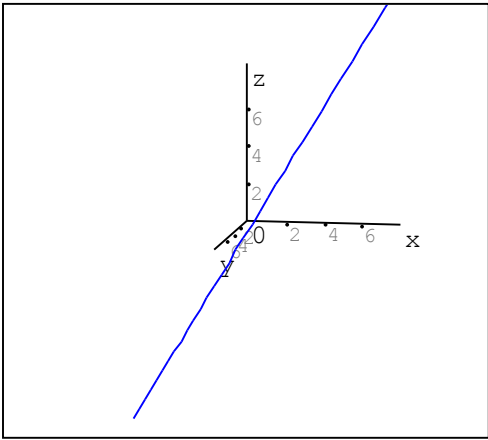

P

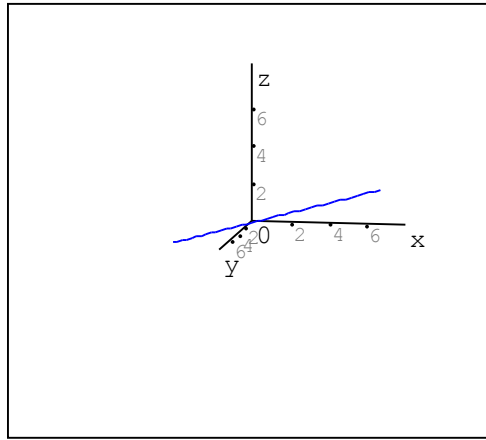

Q

Individual plots of curves given by matrices P and Q.

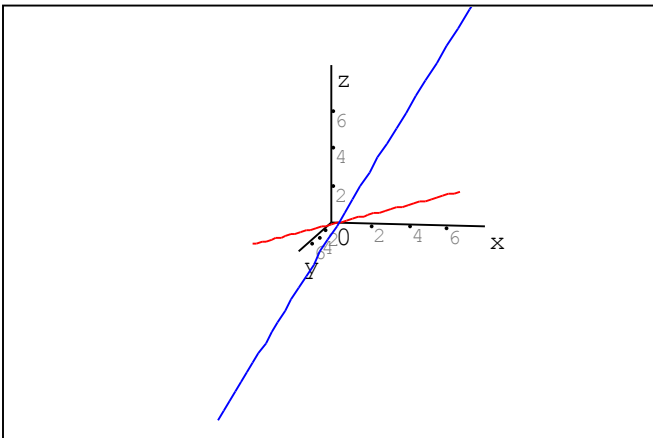

{ P
Q

<--- Join plot of lines given by matrices P and Q

Plot specifications using SMath Studio 0.89 - Release 8

SMath Studio 0.89 - Release 8 includes the ability of specifying four different types of symbols for the graphs, modifying the size of the symbols, and select the color of the symbol. This is accomplished by building a matrix that includes the coordinates (x,y), the character, its size, and the color, in that order.

* Characters: you can select for plotting the characters:

"x" "*" "." "o"

* Size: given in pixels, e.g., 5, 10, 20, 100, etc.

* Colors available (figure below split for printing purposes):

```
aliceblue, antiquewhite, aqua, aquamarine, azure, beige, bisque,
chartreuse, chocolate, coral, cornflowerblue, cornsilk, crimson,
darkkhaki, darkmagenta, darkolivegreen, darkorange, darkorchid,
darkturquoise, darkviolet, deeppink, deepskyblue, dimgray,
ghostwhite, gold, goldenrod, gray, green, greenyellow, honeydew,
lawngreen, lemonchiffon, lightblue, lightcoral, lightcyan,
lightseagreen, lightskyblue, lightslategray, lightsteelblue,
mediumblue, mediumorchid, mediumpurple, mediumseagreen,
midnightblue, mintcream, mistyrose, moccasin, navajowhite, navy,
palegreen, paleturquoise, palevioletred, papayawhip, peachpuff,
saddlebrown, salmon, sandybrown, seagreen, seashell, sienna,
teal, thistle, tomato, turquoise, violet, wheat, white, whitesmoke,
```

```
blanchedalmond, blue, blueviolet, brown, burlywood, cadetblue,
cyan, darkblue, darkcyan, darkgoldenrod, darkgray, darkgreen,
darkred, darksalmon, darkseagreen, darkslateblue, darkslategray,
dodgerblue, firebrick, floralwhite, forestgreen, fuchsia, gainsboro,
hotpink, indianred, indigo, ivory, khaki, lavender, lavenderblush,
lightgoldenrodyellow, lightgray, lightgreen, lightpink, lightsalmon,
lightyellow, lime, limegreen, linen, magenta, maroon, mediumaquamarine,
mediumslateblue, mediumspringgreen, mediumturquoise, mediumvioletred,
navy, oldlace, olive, olivedrab, orange, orangered, orchid, palegoldenrod,
peru, pink, plum, powderblue, purple, red, rosybrown, royalblue,
silver, skyblue, slateblue, slategray, snow, springgreen, steelblue, tan,
yellow, yellowgreen, black
```

You can write them in lower case letters, as shown above, or all in upper case letters, or combinations of upper and lower case letters. For example, you could write in your color specification "darkblue", "DARKBLUE", or "DarkBlue", and the result would be the same. Additionally, you can have spaces in the color specification which will be ignored by SMATH Studio in producing the output to the graphic canvas. For example, you can write "Dark Blue", and it will be interpreted as "darkblue".

NOTE: Any color combination, such as "LightRed", not defined above, will produce, by default, the color black.

EXAMPLE 19 - Plotting a single character or a character string:

You can define a row vector with the properties: (x,y,char,size,color) to write a single character or a string of characters, e.g.,

```
ch01=(2 5 "α" 15 "Blue")
```

```
ch02=(-10 5 "CEE 3510 Hydraulics"15 "red")
```

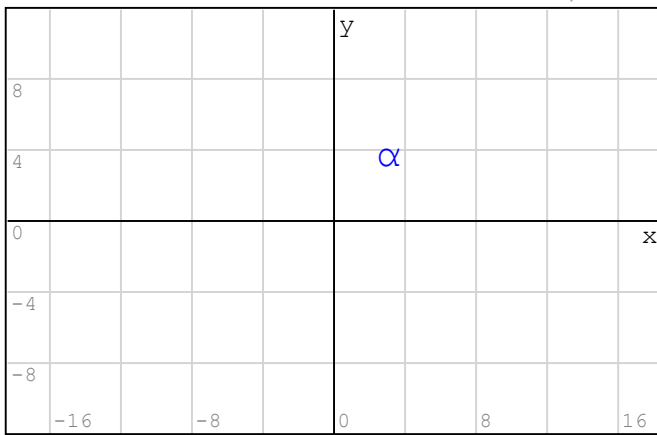

ch01

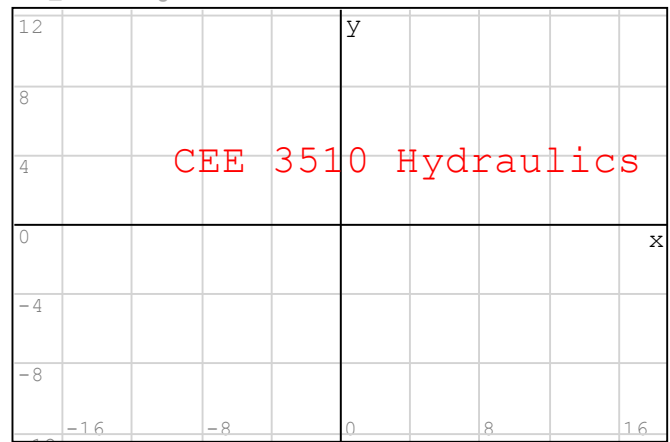

ch02

EXAMPLE 20 - Plotting a matrix of characters:

It is possible to produce a plot including a variety of single characters, or character strings, by creating a matrix in which each row represents an individual string output, e.g.,

```
ch03:=
(
-10 10  "Gilberto E. Urroz"  12  "Red"
-10  5  "CEE 3510 - Hydraulics" 12 "Dark Blue"
-10  0  "Fall Semester 2010"  12  "Green"
-10 -5  "Using SMath Studio"  12 "Dark Green"
-10 -10 "Utah State University" 12  "Blue"
)
```

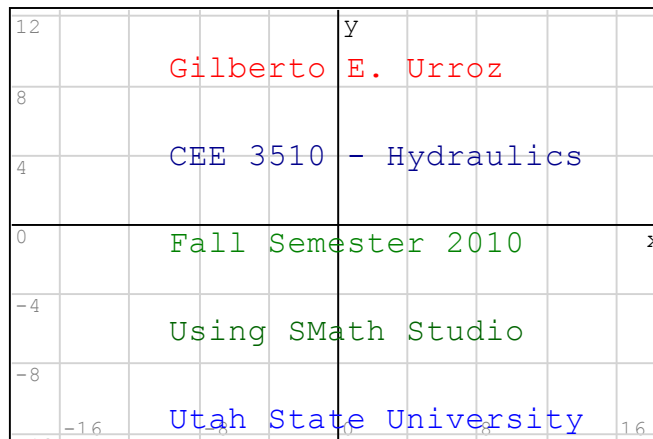

ch03

A program to plot single data sets with different symbols, sizes, and colors

The following program was made available by Prof. Radovan Omorjan in the SMath Studio Forum. The program takes vectors of values (x, y) and creates a plot matrix for the data using a specified character (char), size, and color. This program operates only in SMath Studio version 0.89 release 8, and later. The expression for the program, or function, is:

```
plotG(x, y, char, size, color):=
|
n:= length(x)
plot:= augment(x_1, y_1, char, size, color)
for i∈ 2..n
  plot:= stack(plot, augment(x_i, y_i, char, size, color))
plot
```

EXAMPLE 21 - Plotting data (x,y) with function "plotG"

The following graphs show the plotting of the function $y = \sin(x)$, with values of x between 0 and 10, in increments of 0.5, using different symbols, sizes, and colors. The data is generated here:

```
x:= 0 , 0.5 .. 10    n:= length(x)    n= 21
```

```
for k∈ 1 .. n
  yk:= sin(xk)
```

The plots are shown below:

```
plot1:= plotG(x, y, ".", 25, "Light Green")
```

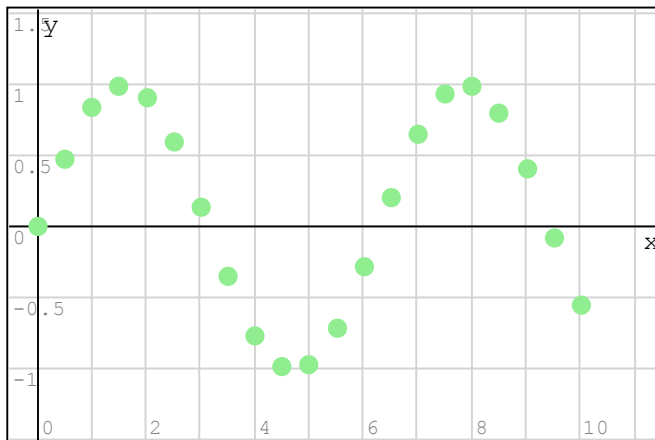

plot1

```
plot2:= plotG(x, y, "+", 35, "Magenta")
```

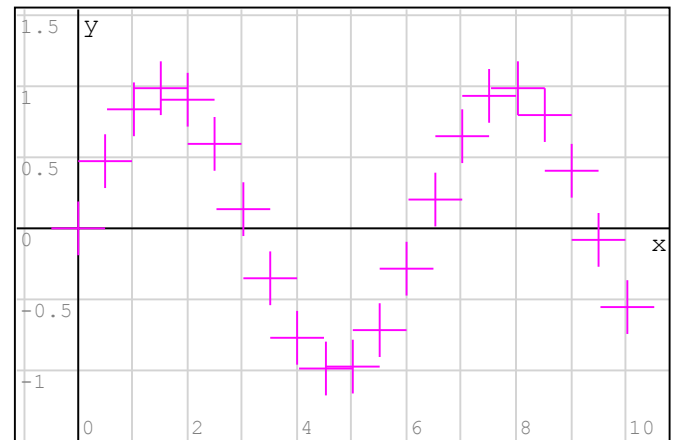

plot2

```
plot3:= plotG(x, y, "x", 25, "Dark Blue")
```

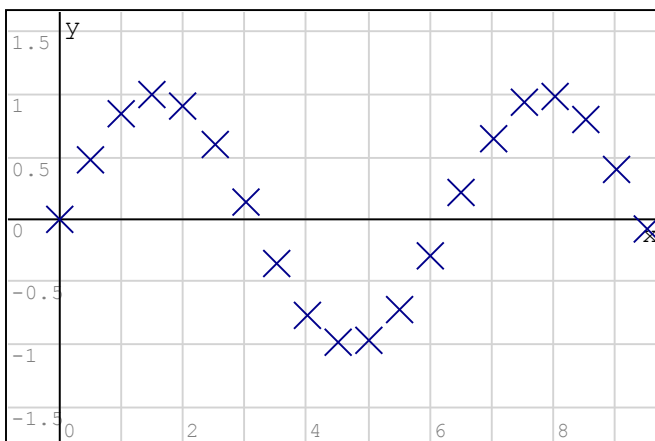

plot3

```
plot4:= plotG(x, y, "o", 20, "Violet")
```

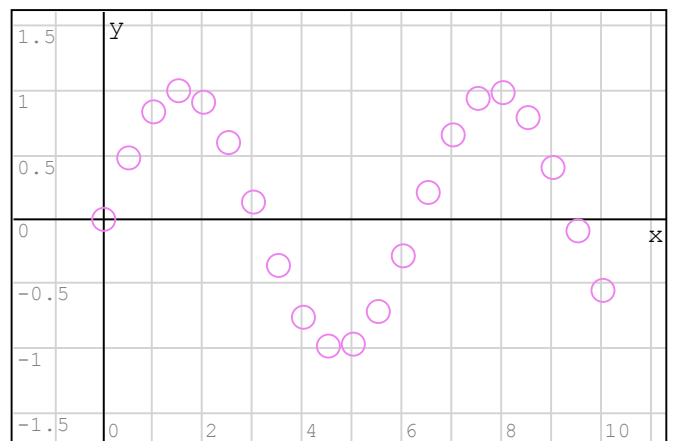

plot4

EXAMPLE 21 - Plotting various data (x,y) with function "plotG"

The following graphs show the plotting of the function $y = \sin(x)$, with values of x between 0 and 10, in increments of 0.5, using different symbols, sizes, and colors. The data is generated here:

```
x:= 0 , 0.5 .. 10    n:= length(x)    n= 21
```

```

for k ∈ 1 .. n
  
$$\begin{cases} y_k := \sin(x_k) \\ z_k := \sin(2 \cdot x_k) \\ r_k := \cos(3 \cdot x_k) \end{cases}$$

```

The individual plots of (x, y) , (x, z) , and (x, r) are given by sY, sZ, and sR:

```

sY:=plotG(x, y, ".", 25, "Blue")
sZ:=plotG(x, z, "o", 20, "Red")
sR:=plotG(x, r, "x", 15, "Magenta")

```

The following matrices combine plots of various data sets:

```

MYZ:=stack(sY, sZ)           MZR:=stack(sZ, sR)
MYR:=stack(sY, sR)         MYZR:=stack(sY, sZ, sR)

```

Some plots based on the matrices, and the original functions used to produce the matrix data, are shown next:

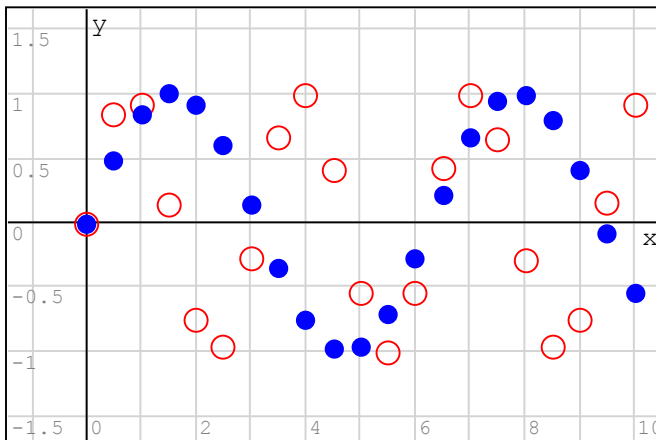

MYZ

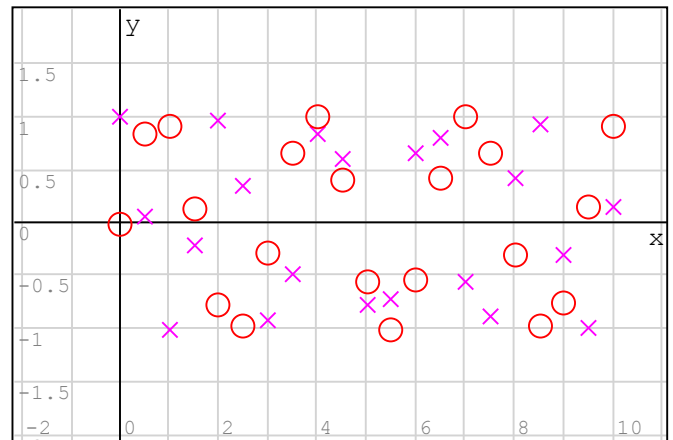

MZR

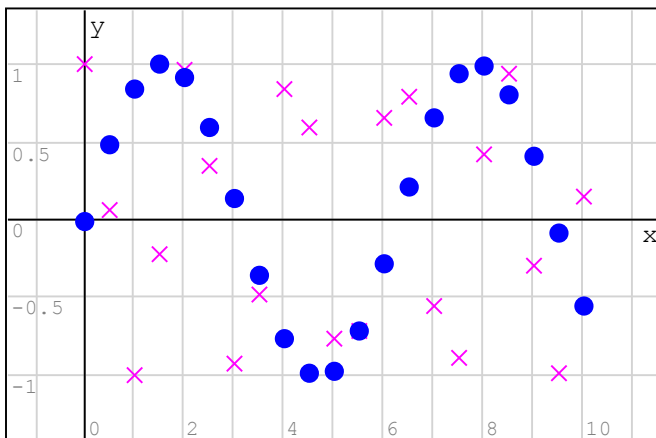

MYR

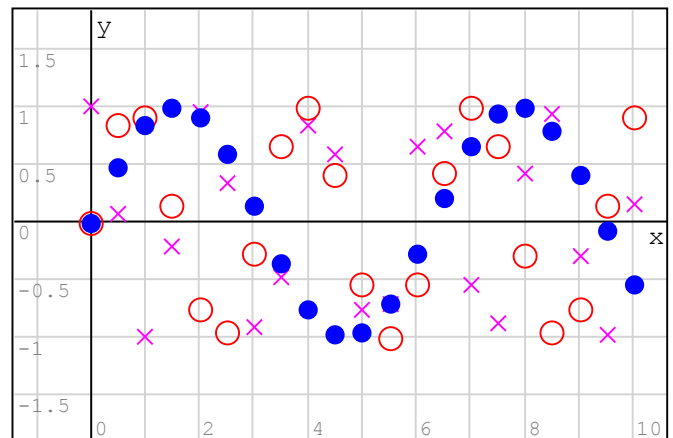

MYZR

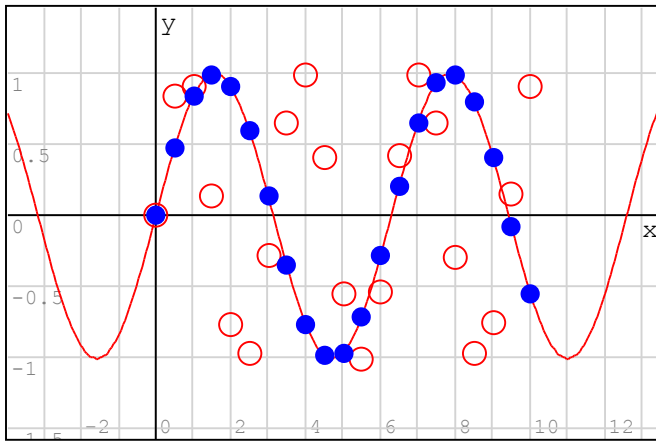

{ MYZ
 { sin(x)

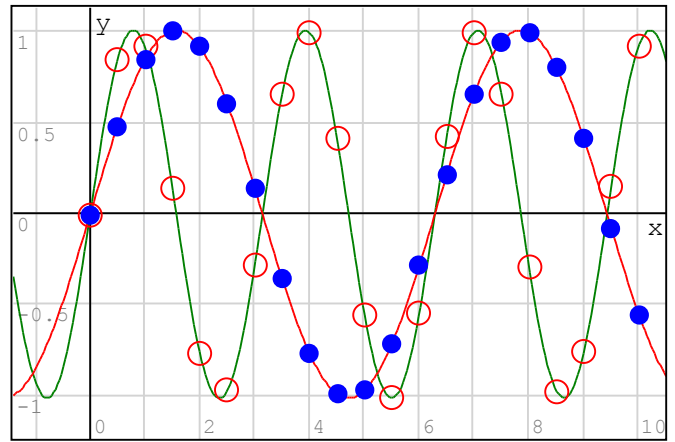

{ MYZ
 { sin(x)
 { sin(2*x)